



MANUAL – INSTALLATION

---

# BACnet Wiring Guidelines

## For Price Controls

v300 – Issue Date: 01/16/23

© 2023 Price Industries Limited. All rights reserved.



# BACNET WIRING GUIDELINES

## TABLE OF CONTENTS

### Product Overview

General.....	1
Power (24 VAC) .....	1
Network Wire Specifications .....	2
Wire Routing .....	3
Electrical Noise .....	5
Termination .....	5
BACnet MS/TP Speeds .....	6
Addressing .....	7
Setting the Device Instance (Coupled With MAC and DI).....	9
Setting the Device Instance (DeCoupled With MAC and DI).....	10
Setting the BACnet Address with LCD Thermostat.....	11
Troubleshooting .....	13

# BACNET WIRING GUIDELINES

## PRODUCT OVERVIEW

### General

Typically BACnet controllers are networked using the BACnet MS/TP protocol. BACnet MS/TP is based on a physical RS-485 network. Baud rates officially support by ASHRAE 135 are 9600, 19200, 38400, 76800 (and 115,000 is slowly being adopted).

BACnet MS/TP offers a simple low cost way to connect controllers together and allows them to share data. MS/TP is not intended for very high bandwidth, but offers advantages in being very robust, noise immune and low cost.

**Price offers a variety of BACnet controllers that support MS/TP and all Price controllers use a default baud rate of 76,800.**

### Power (24 VAC)

Price Controllers use 24 VAC as their power source. Each controller has a terminal labeled 24 VAC Hot and Com. Polarity on the power is important and must be observed. Also **the 24 VAC common side of the transformer MUST be Earth grounded**. This is for safety and also ensures reliable BACnet communication. If power is reversed the controller will still power up, but the BACnet network will not function. Also any analog signals sent to other devices will be incorrect. Common symptoms of a poorly grounded network can include inconsistent BACnet MS/TP communications, and damage from voltage spikes.

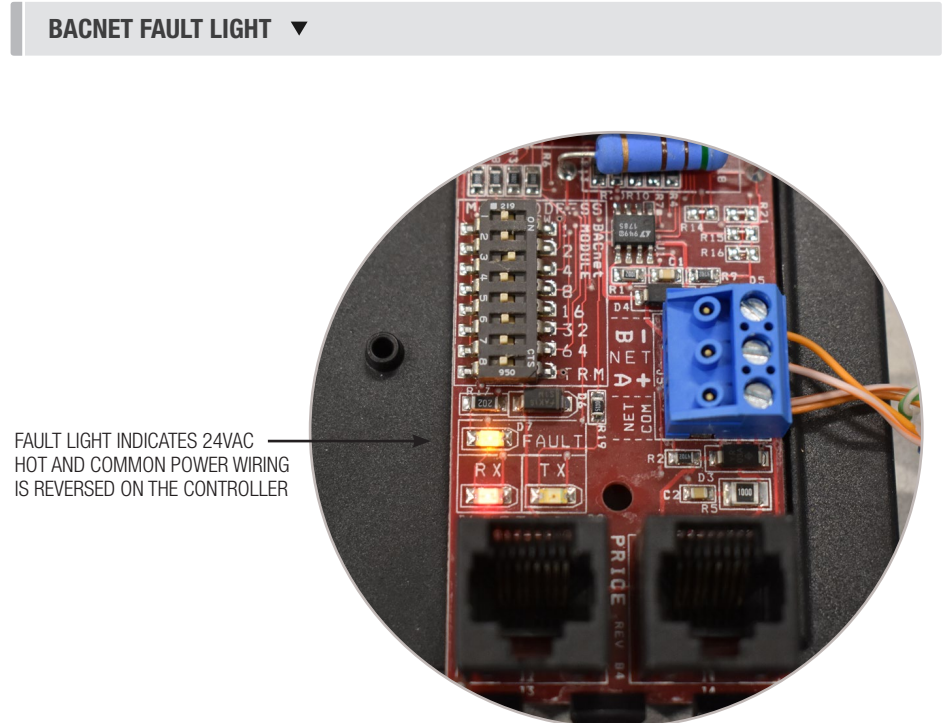
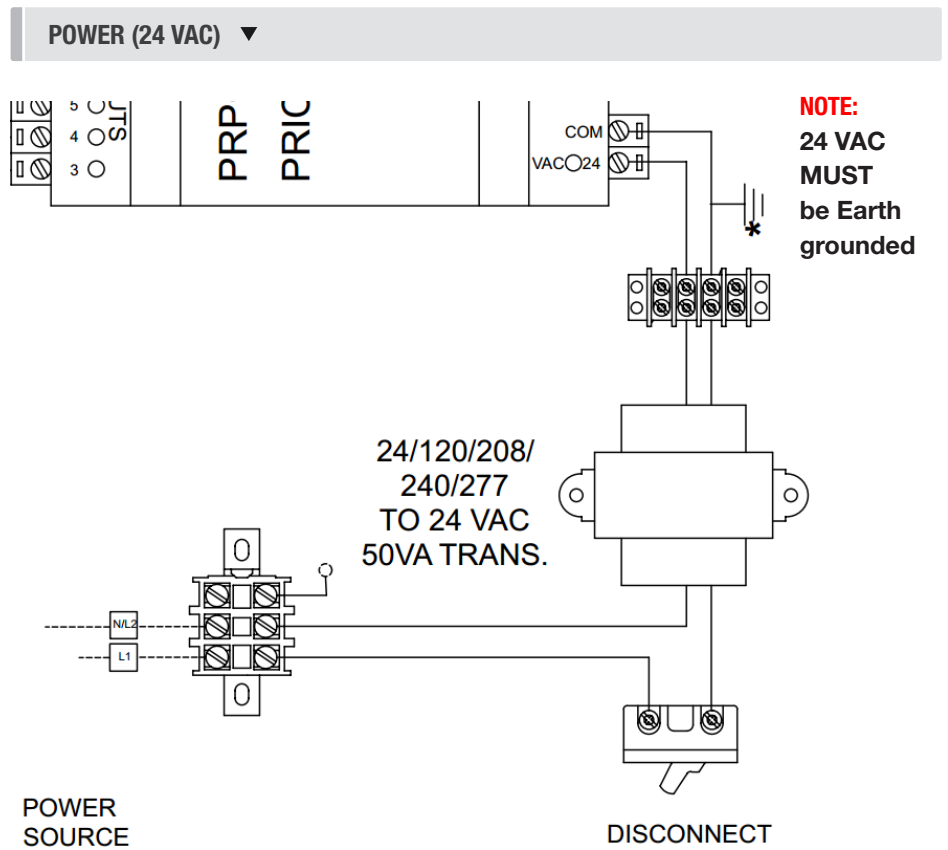

# BACNET WIRING GUIDELINES

## PRODUCT OVERVIEW

### Network Wire Specifications







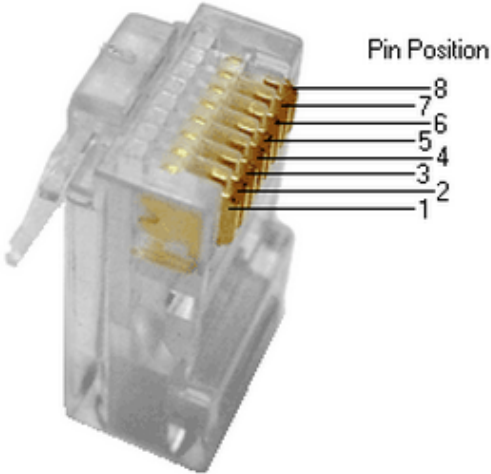

For the BACnet MS/TP network, specific wire is required. Do not use standard power or “thermostat” wire. This wire does not have the necessary requirements for digital communications. While it’s possible it may work (temporarily) the network will be unreliable and not operating at optimal.

### BACnet MS/TP Wire type recommendations

- Low capacitance (17pF or less)
- Plenum rated (FT6, CMP ratings)
- 100-120 ohm, Balanced
- (CAT5, CAT5E, CAT6 network cable has excellent specifications and will work in almost any BACnet MS/TP application.)
- **Price recommends using the Orange Complement for (+), the Orange for (-), and the Brown and Brown Complement for the (NET COM) connections. These are paired in a standard CAT5E cable.** Pre-terminated CAT5 cables are available from Price. Model code: NETC35 (35 ft plenum rated cable, terminated with RJ45 plugs, 568-B standard)

**NOTE: NETCOM MUST BE WIRED**

WIRING ▼

	T568B Color	Pins on plug face (socket is reversed)
PIN 1	 white/orange stripe	
PIN 2	 orange solid	
PIN 3	 white/green stripe	
PIN 4	 blue solid	
PIN 5	 white/blue stripe	
PIN 6	 green solid	
PIN 7	 white/brown stripe	
PIN 8	 brown solid	



# BACNET WIRING GUIDELINES

## PRODUCT OVERVIEW

### Wire Routing

BACnet MS/TP networks must be wired in a daisy chain configuration. A daisy chain means that there is only one main cable, and every network device is connected directly along its path. This type of network is low bandwidth, but reliable and good for long distance multi-drop runs.

Other methods of wiring a MS/TP BACnet network may give unreliable and unpredictable results. DO NOT use Star, Bus, "T", or any other type of network configuration. Any of these other network configurations will result in an unreliable network, and make troubleshooting almost impossible.

To create the daisy chain configuration, simply bring 2 network wires to the controller, then using either the pluggable terminal block or the Price RJ45 connection continue to the next controller. Connect + to +, - to -, and NET COM to NET COM on up to 30 controllers. As always, ensure that polarity is maintained on power and the network.

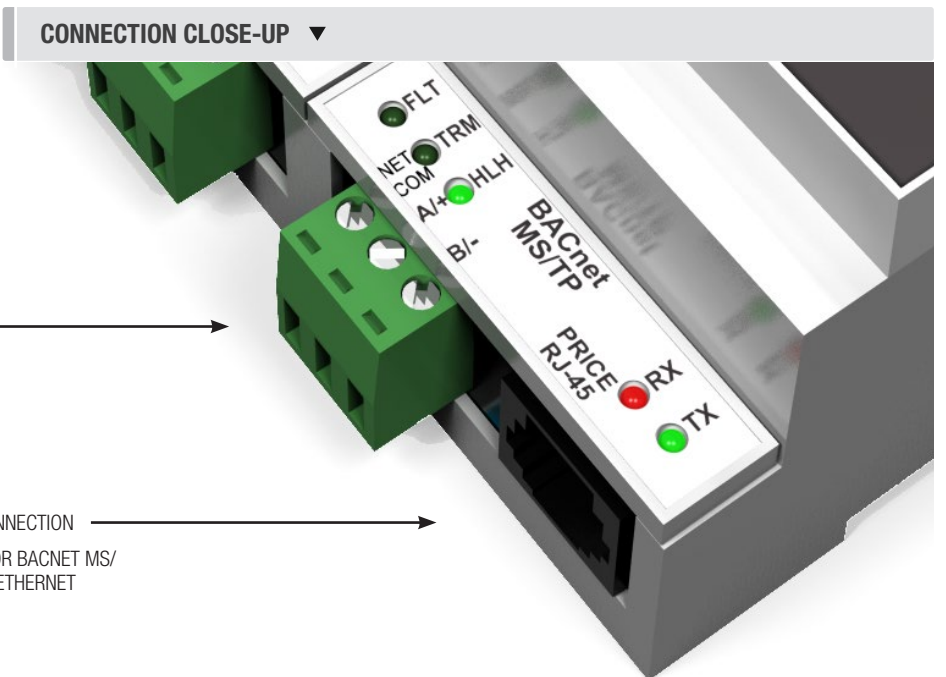
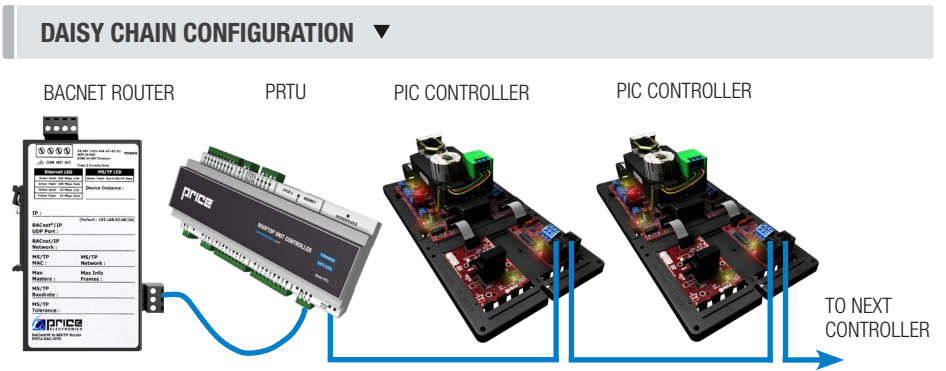

# BACNET WIRING GUIDELINES

## PRODUCT OVERVIEW

### Wire Routing Continued

#### CONNECTION EXAMPLE ▼

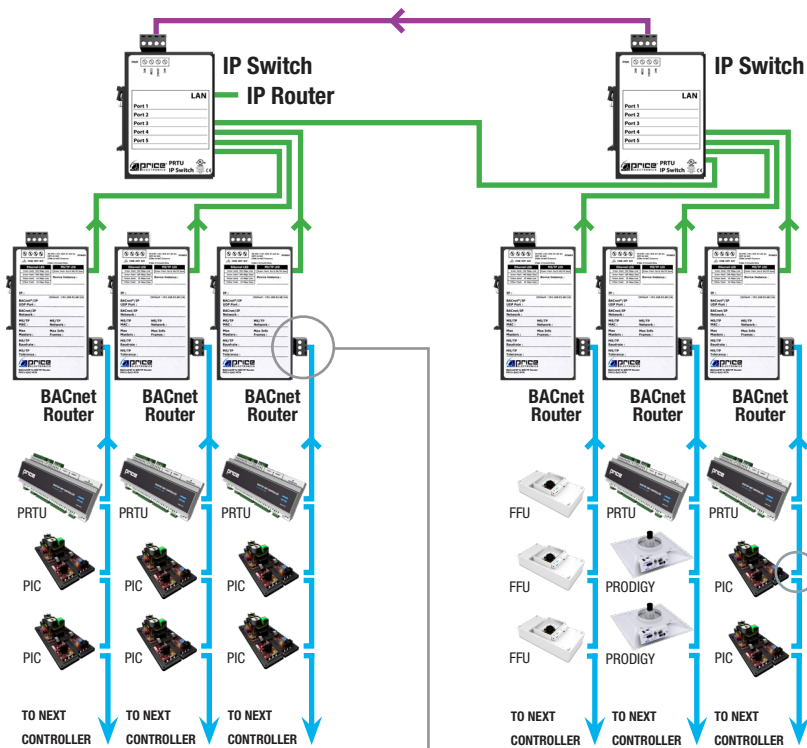
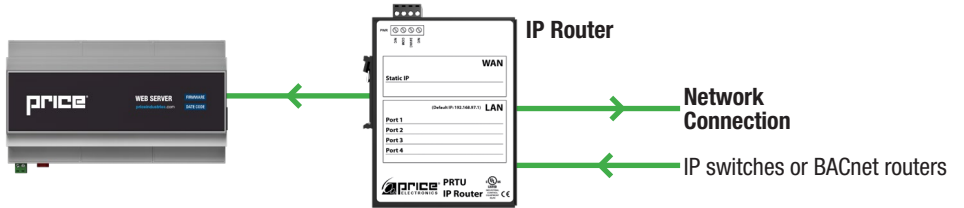
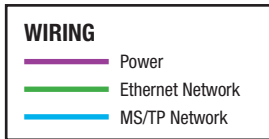

- Up to 30 devices on each BACnet router.

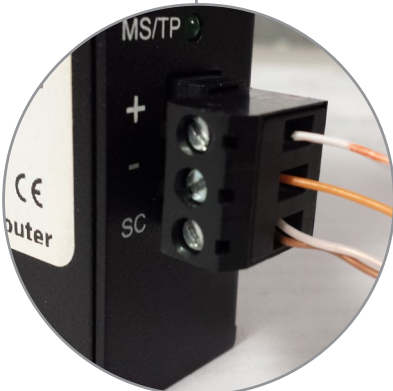
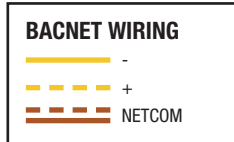

**NOTE:** BACnet terminal block and plug-and-play wiring can be used interchangeably.

# BACNET WIRING GUIDELINES

## PRODUCT OVERVIEW

### Electrical Noise

Electrical noise can affect both analog signal and digital communications such as BACnet. Therefore do not route high voltage lines next to the BACnet network! Avoid noisy electrical sources such as:

- Variable Frequency Drives
- High current power lines (main panel feeds)
- Fluorescent light fixtures

If you must pass near noisy electrical lines cross at right angles. This will help reduce the amount of noise coupled to the network wires.

### Termination

BACnet MS/TP networks must be terminated to ensure proper operation. A network should be terminated twice, once at the beginning and once at the end. Termination helps reduce reflections and noise. The terminating can be done with a 100 ohm resistor across the + and - lines. Most Price controllers have the option for enabling termination via a DIP switch #8 or by a software menu selection. Turning on termination via software will enable the resistor across the lines and also turn on a green LED labeled "TRM".

**Tech Tip:** The Price BACnet MS/TP to IP Router has built in termination and it is enabled by default (since the router is typically the beginning of the entire MS/TP network). Now you only have to go and find/terminate that last device.

### ELECTRICAL NOISE EXAMPLE ▼

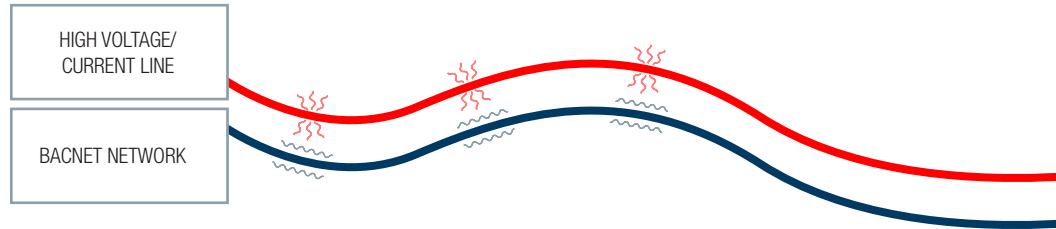

### CONNECTION CLOSE-UP ▼



# BACNET WIRING GUIDELINES

## PRODUCT OVERVIEW

### BACnet MS/TP Speeds

The default speed for Price BACnet MS/TP controls is 76800. The BACnet standard REQUIRES a device to support at least 9600 baud.

BACnet MS/TP supports 4 standard speeds which are:

- 9600
- 19200
- 38400
- 76800 (Price Default)

All controls on the same network segment MUST be set to the SAME speed.

### PRICE BACNET MODULE USED ON THE PIC CONTROLLER ▼

DIP SWITCHES  
FOR SETTING THE  
MAC. →

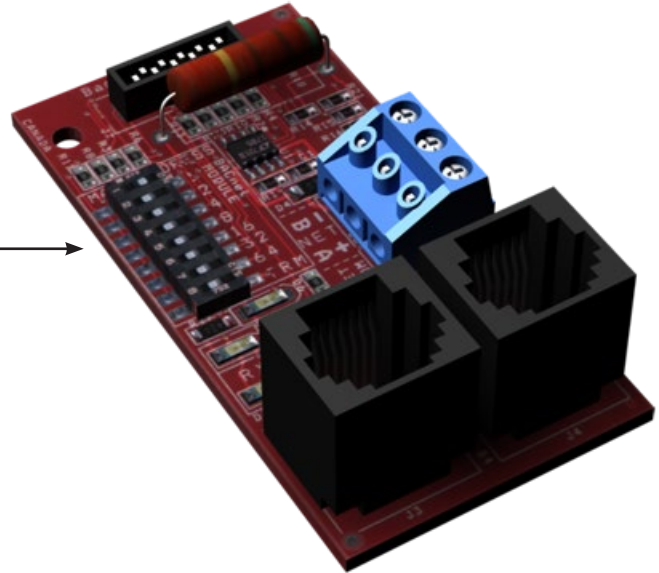



# BACNET WIRING GUIDELINES

## PRODUCT OVERVIEW

### Addressing

Each device on an MS/TP segment must have a unique MAC (media access control) address, typically 1-99. Duplicate addresses will cause the network to fail and not communicate.

A Device Instance number identifies a device within an entire building, therefore giving it a unique number, much like a telephone ext. number. A building can have one telephone number, but all the extensions have a unique number to identify them. A Device Instance number would work the same way and must be unique throughout the building.

Addresses (both MAC and SOFTWARE) are typically set in software via an LCD interface/thermostat or computer program. Dip switches are available on some products to set the MAC.

### ADDRESSING SCHEME ▼

#### MS/TP NETWORK RUN IN DAISY CHAIN FORMAT



### DIP SWITCH FOR SETTING MAC ADDRESS ▼

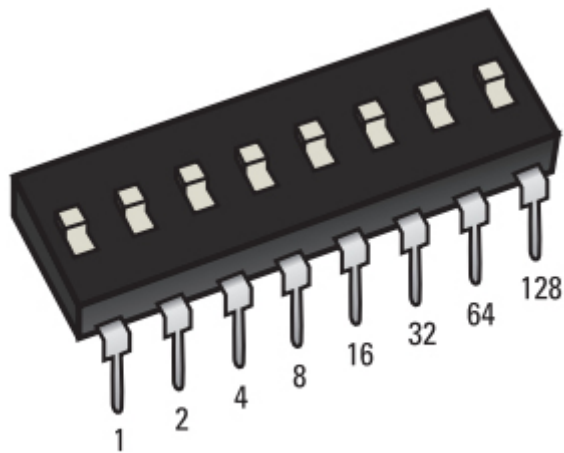

Dip Switch ON	Value	Notes
1	1	
2	2	
3	4	
4	8	
5	16	
6	32	
7	64	
8	TRM	Price uses DIP switch 8 for enabling R/C termination of the MS/TP network

# BACNET WIRING GUIDELINES

## PRODUCT OVERVIEW

### Addressing Continued

MAC (media access control) must be UNIQUE on an MS/TP network segment within building. An installer setting up an MS/TP segment with 30 devices must ensure each device has a UNIQUE MAC Address (Range 1-99). The MAC Address is set through the LCD thermostat.

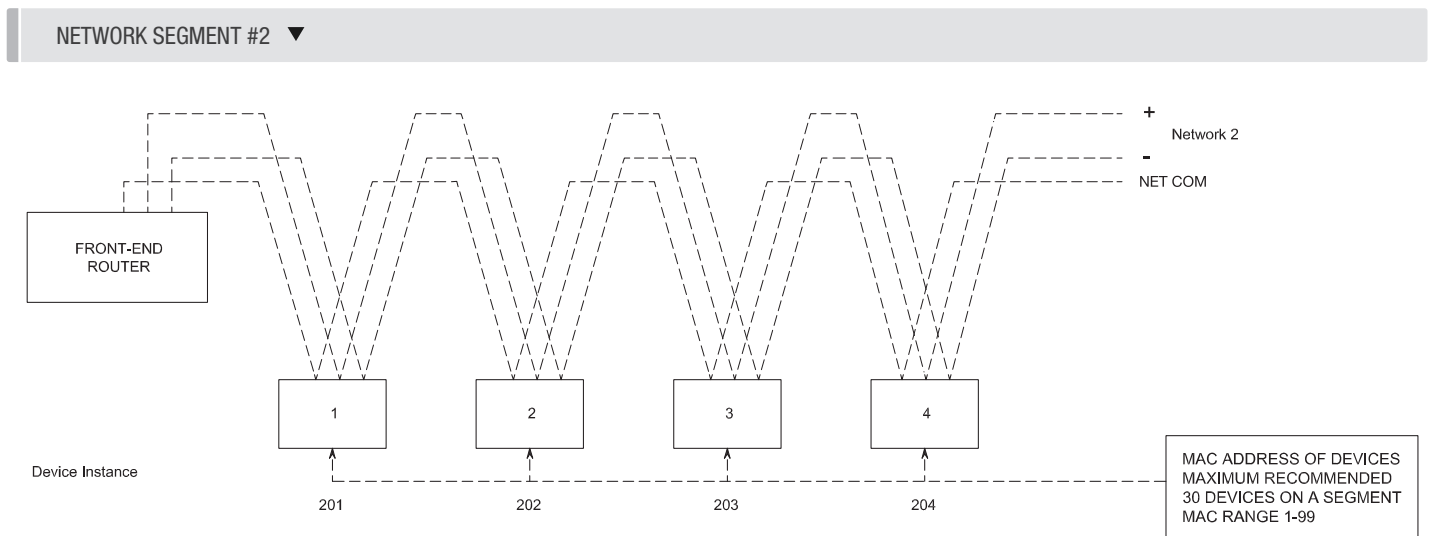
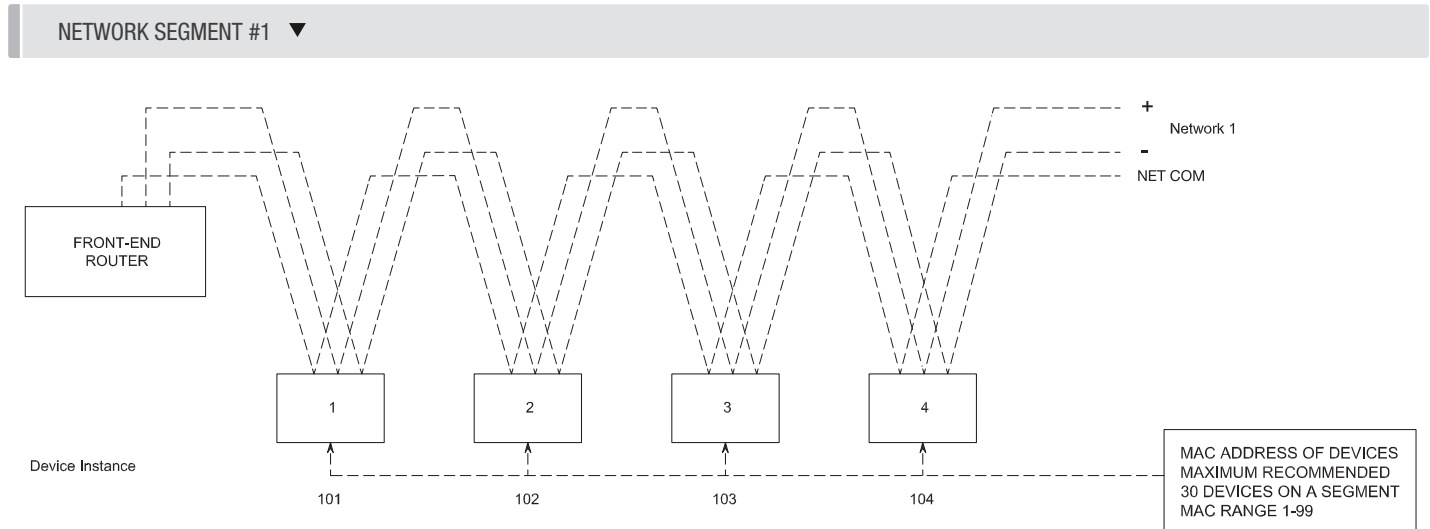

### TECH TIP ▼

Each device needs a unique MAC and Device Instance. All devices must be at the same baud rate. 24 VAC HOT and COMMON polarities are critical and must not be reversed on ANY devices! Reverse polarity will stop communication on that MS/TP segment.

NET COM wire must be connected at each device and is critical for BACnet network reliability.

Use one twisted pair for + and -, and another twisted pair for NET COM for optimal noise cancellation.

# BACNET WIRING GUIDELINES

## PRODUCT OVERVIEW

### Setting the Device Instance (Coupled MAC and DI)

The Device Instance number is user set through the LCD Thermostat or LCD-SETUP tool. See page 10 for further instruction.

Below is a table defining how a Device Instance number is obtained.

**NOTE:** Each device on a network segment must be set to run at the same speed or baud rate.

Description	Default Value (Factory)	Notes
MAC Address	6	Value: limited to 1-99
Tier1 (x100)	58	Value: limited to 0-99
Tier2 (x10,000)	1	Value: limited to 0-99
Tier3 (x1,000,000)	0	Value: limited to 0-4

### Example Device Instance setup with Default settings:

- MAC Address = 6 (6 x 1 = 6) – Set through software

+

TIER 1 = 58 (58 x 100 = 5800) – Set through software

+

TIER 2 = 1 (1 x 10,000 = 10,000) – Set through software

+

TIER 3 = 0 (0 x 1,000,000 = 1,000,000) – Set through software

=

Final Device Instance = 0,015,806

	<input type="text" value="0"/>	<input type="text" value="01"/>	<input type="text" value="58"/>	<input type="text" value="06"/>
	Tier3	Tier2	Tier1	MAC
	Multiplier	Multiplier	Multiplier	Address

# BACNET WIRING GUIDELINES

## PRODUCT OVERVIEW

### Setting the Device Instance (De-coupled MAC and DI)

A Device Instance number identifies a device within an entire building, therefore giving it a unique number or Address, much like a telephone ext. number. A building can have one telephone number, but all the extensions have a unique number to identify them. A Device Instance number would work the same way and must be unique throughout the building. The Device Instance number is user set through the LCD Thermostat or LCD-SETUP tool.

Below is a table defining how a Device Instance number is obtained.

**NOTE:** Each device on a network segment must be set to run at the same speed or baud rate.

Description	Example Value	Notes
Tier 1 (x01)	4	Value: limited to 1-99
Tier 2 (x100)	58	Value: limited to 0-99
Tier 3 (x10,000)	1	Value: limited to 0-99
Tier 4 (x1,000,000)	0	Value: limited to 0-4

### Example Device Instance setup with table settings from above:

- TIER 1 = 4 (4 x 1 = 4) – Set through software

+

TIER 2 = 58 (58 x 100 = 5800) – Set through software

+

TIER 3 = 1 (1 x 10,000 = 10,000) – Set through software

+

TIER 4 = 0 (0 x 1,000,000 = 1,000,000) – Set through software

=

Final Device Instance = 0,015,804

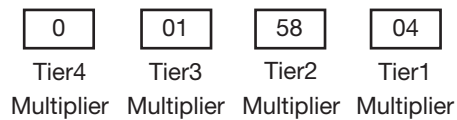

# BACNET WIRING GUIDELINES

## PRODUCT OVERVIEW

### Setting the BACnet Address With LCD Thermostat

Each controller's MAC address, Device Instance, and Baud rate are set in the BACnet sub-menu of the service menu accessed through an LCD thermostat or LCD setup tool. For information on how to select a MAC address and Device Instance for any controller on a network, see the following pages.

To set the controller's BACnet settings, enter the Service Menu and adjust settings as follows:

**NOTE:** When the screen displays a flashing value, that value is ready to be changed and can be adjusted by pressing the arrow keys. Pressing Menu will save the value.

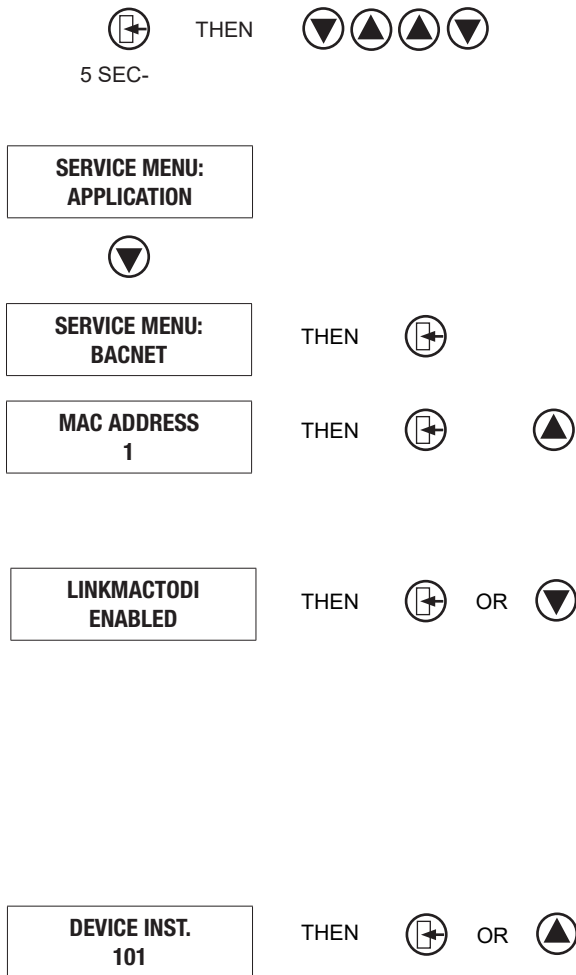

Hold down the **Menu** button on the LCD Thermostat for **5 seconds** until prompted for a passcode; use **▲** and **▼** to enter the passcode; **DOWN, UP, UP, DOWN**.

The screen will now display "Service Menu: Application."

Scroll down to the BACnet sub-menu.

Press the **Menu** button to enter this menu.

Screen will now show "MAC Address." Press **Menu**, and now "1" will begin flashing; this means you can now scroll **UP** or **DOWN** with the arrow keys to select a new MAC address. Once you arrive at your desired number, press **Menu** to save.

By default, the MAC address will appear as the last 2 digits of the device instance. This can be changed so that the MAC is completely independent of the device instance by changing 'Enabled' to 'Disabled'. If there is no specific need to do this, Price recommends leaving it enabled (for Price PRTUs systems and most other scenarios, there is no need to switch to disabled).

The device instance defaults to 100, but will be displayed with the last 2 digits as the MAC if the previous screen was set to enabled. Press **Menu** then use the arrow keys to change the device instance.

**NOTE: Each Menu press will allow changes in different tiers of the device instance (so that you don't have to scroll for extended periods to get into the millions range - supposing that's where you need to set your device instance).**

# BACNET WIRING GUIDELINES

---

## PRODUCT OVERVIEW

### Setting the BACnet Address With LCD Thermostat Continued

To set the controller's BACnet settings, enter the Service Menu and adjust settings as follows:

**NOTE:** When the screen displays a flashing value, that value is ready to be changed and can be adjusted by pressing the arrow keys. Pressing Menu will save the value.



THEN



OR



The baud rate is the speed that the MS/TP network runs at. EVERY device on the network must run at the same speed. Price controllers are defaulted to a baud rate of 73800, but can be changed to 38400, 19200, or 9600. For a network segment with all Price controllers (including Price PRTU systems), it's recommended that the baud rate be left at 76800.

\*Choose lower baud rates only when integrating with devices by other manufacturers whose maximum speed is lower than 76800 (eg. 38400).

Once all settings are made, scroll down to press **Menu** to exit, and press **Menu**. The controller will then re-start, this is because all BACnet info is only read once at startup. If you had left the MAC set in hardware, and adjusted the DIP switch settings to set the MAC address, you would have to manually restart the controller by cycling 24 VAC power for the new MAC address to take effect (setting through software makes the restart happen automatically however).

# BACNET WIRING GUIDELINES

## PRODUCT OVERVIEW

### Troubleshooting

1. Check all your 24 VAC HOT/COMMON polarities. While there ensure COMMON is EARTH GROUNDED.
2. Ensure all MAC addresses are unique for that MS/TP segment. If you have 2 addresses that are the same that means 2 devices are talking at the same time.
3. Ensure all device instances are unique for that BACnet network.
4. Ensure all devices are running at the same baud rate. The Price default is 76,800. Confirm this someone may have changed it.
5. Chop network in half. Does it start to work? Keep chopping until network comes online. This will help narrow down the problem.
6. Have more than 30 MS/TP devices on one segment? Not recommended. Break up that segment into separate ones with the Price MS/TP BACnet router.
7. Have a MS/TP segment that goes over 1050 feet? Not recommended. Break up that segment.
8. Check termination. Ensure only 2 devices in total are terminated for that MS/TP segment.
9. Do you have other BACnet (non Price) devices on the network? Remove them while troubleshooting. If they are causing issues put them on a separate MS/TP segment.
10. Use the Price BACnet Commissioning Tool (BCT) aka Dr. BACnet to help diagnose the network. Available from your local representative on quick ship.
11. Use the Price BACnet Router (PRTU-BAC-RTR) diagnostic page to help determine what devices are active on the network (when provided).

## PRICE BACNET COMMISSIONING TOOL ▼

Price Electronics BACnet Commissioning Tool v0.13

File View Help

# BACnet MS/TP Mode

COM Port: COM6 Baud: 76800 Stop Listening

MS/TP Segment Overview MS/TP Devices

MS/TP Network

MAC	Last Seen	Last Frame Type
10	29ms	BACnetDataNotExpectingReply
11	94ms	Token
13	95ms	Token
14	80ms	Token
15	80ms	Token
52	30ms	Token
0	15ms	Token
8	15ms	Token

Device Traffic Breakdown (last 512 frames)

Device Details

Device MAC Address: 0

Lorem ipsum dolor sit amet, consectetur adipiscing elit. Vivamus pellentesque congue rhoncus. Nulla iaculis purus id enim congue tempus id egestas velit. Sed tempus dapibus risus, quis interdum quam fringilla ac. Aenean sagittis ultrices tempus.

# BACNET WIRING GUIDELINES

## PRODUCT OVERVIEW

### Troubleshooting Continued

The Price BACnet Router (PRTU-BAC-RTR) features a diagnostic page that can be used to diagnose your network.

#### PRTU-BAC-RTR DIAGNOSTIC PAGE ▾



Configuration    Advanced    Routing    Security    **Status**    BDT    FDT

## PRTU-BAC-RTR Configuration

From the top navigation, select the Status tab to open the diagnostic page. This page will automatically refresh every 5 seconds with the updated status on BACnet networks and devices to which the BACnet router is connected.



### PRTU-BAC-RTR Status

#### MSTP Device Status

0	1	2	3	4	5	6	7	8	9	10	11	12	13	14	15
16	17	18	19	20	21	22	23	24	25	26	27	28	29	30	31
32	33	34	35	36	37	38	39	40	41	42	43	44	45	46	47
48	49	50	51	52	53	54	55	56	57	58	59	60	61	62	63
64	65	66	67	68	69	70	71	72	73	74	75	76	77	78	79
80	81	82	83	84	85	86	87	88	89	90	91	92	93	94	95
96	97	98	99	100	101	102	103	104	105	106	107	108	109	110	111
112	113	114	115	116	117	118	119	120	121	122	123	124	125	126	127

Green=Online    Blue=Router MAC    Gray=Offline

Network Errors: 0    ← ACCUMULATED BACNET MS/TP ERRORS

#### Statistics

B/IP 1 In Packets	B/IP 1 Out Packets	B/IP 2 In Packets	B/IP 2 Out Packets
1786156	253009	0	0
B/Eth In Packets	B/Eth Out Packets	MSTP In Packets	MSTP Out Packets
0	0	242531	981205
TX PFM Count	RX PFM Count	TX Token Count	RX Token Count
1	1	6784924	6784924
Invalid long Frames	Next Station	SoleMaster	
0	1	No	

Reset Statistics    ← RESETS NETWORK ERRORS COUNT, AND STATICS, WHILE RETAINING THE MS/TP DEVICE STATUS TABLE HISTORY.

The IP address should match what is on the router itself, the MAC address should be set to 0 (zero) and the baud rate is defaulted to 76800.





---

This document contains the most current product information as of this printing.  
For the most up-to-date product information, please go to [priceindustries.com](http://priceindustries.com)

© 2023 Price Industries Limited. All rights reserved.

